

## DESCRIPTION

CPM-10 Multifunction meter product single phase, three phases high accuracy measurement of parameters such as voltage, current, active power, reactive power, apparent power, power factor, frequency, effective energy, with display and remote communication function. Option 1 set relay output, 1 analogue and 1 RS485 (Modbus RTU Mode) or 1 pulse output. Most suitable for power management, remote input/output, alarm and remote signal control uses needs. Having case depth 120mm only, easy panel mounting installation.



## FEATURE

- Input 1P2W, 1P3W, 3P3W, 3P4W Unbalanced/Balanced load system's active power, reactive power, apparent power and electric energy (Watts-Hr) etc parameters.
- Dual display, upper row 4 digits for voltage/ 4 digits for current ( or 10 digits Watts-Hr), lower row 4 1/2 digits Watts.
- 1 set relay (SPDT) output, with 3 variable setting (R1.1/R1.2/R1.3), each react to setting parameters V.AVG/I.AVG/FREQ/P.TL/Q.TL/ S.TL / PF.AVG / AE.TL / RE.TL / VA / VB / VC / IA / IB / IC / PF-A / PF-B / PF-C / P-A / P-B / P-C / Q-A / Q-B / Q-C / S-A / S-B / S-C, having relay function : Hi / Lo / Hi Hold / Lo Hold / Do / OFF; further advance function , start delay, hysteresis, time delay, reset delay etc
- 1 analogues output same as relay setting parameters.
  - Output range: Current 0~10mA / 0~20 mA / 4~20 mA / 4~±20 mA / ±10 mA / ±20 mA (Default 4-20mA)
  - Output range: Voltage 0~5V / 1~5 V / 0~10 V / 0~±5 V / 1~±5 V / 0~±10 V / ±5 V / ±10 V (Default 0-10V)
- Option pulse and RS 485 communication output.
- Outer case standard DIN 96 x 48 mm
- Product design according to CE.

## Application

Motor control/ panel power monitoring/power consumption monitor and control/power distribution system /intelligent building & automation power management system/ power testing equipment

## ORDERING INFORMATION

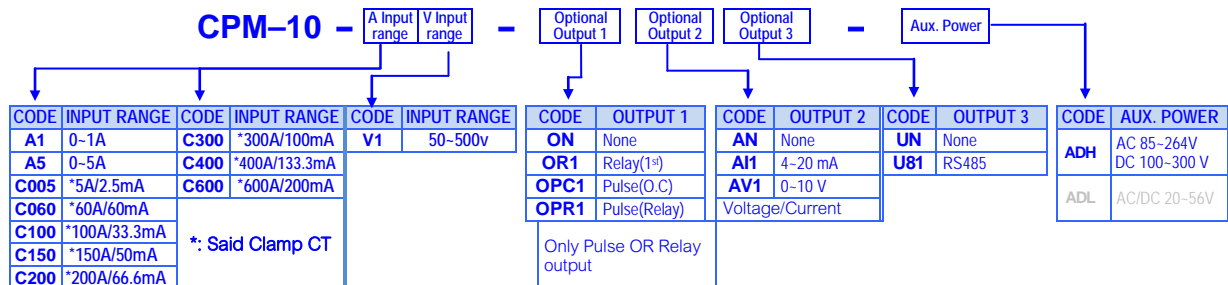

## TECHNICAL SPECIFICATION

### Measurement and connection

Connection	Input range			Input consumption
	Voltage	Amp.	Freq.	
1P2W	50~500Vac(VL-N)	1A 5A	45~65 Hz	Voltage: ≤0.5VA/Phase or Current: ≤0.1VA/Phase
1P3W				
3P3W				
3P4W				

\* Max input 500V, 5A, if exceed please use PT or CT

Accuracy and resolution (Accuracy add 1.0 % when selected the Clamp Type)

Parameters	Accuracy	Max. Resolution	Display Range
Voltage	0.2%	0.1 V	0~2999.9
Current	0.2%	0.02 A	0~2999.9
Active	0.5%	0.001 kW	-19999~29999
Reactive	0.5%	0.001 kVar	-19999~29999
Apparent	0.5%	0.001 kVA	-19999~29999
Power factor	0.5%	0.001	-0.020~1.000~+0.020
Frequency	0.2%	0.01 Hz	45.00~65.00
Effective	0.5%	0.001 kWh	0~9999999999
Ineffective	0.5%	0.001 kVarh	0~9999999999

### Input

**Measurement:** True RMS Value  
**Ripple effect:** ≤ 0.2% of F.S. at 30% distortion  
**A/D converter:** 16 bits A/D converter

**Sampling rate:** 128point/Cycle  
**Response time:** ≤100 ms (Average value set as = "1")  
**System:** 1P2W, 1P3W, 3P3W, 3P4W;  
 Unbalanced / Balanced load

### Input range:

**Voltage: 50~500V L-N**  
 Primary shunt unit setting: V and KV  
 PT Primary setting: 50.0V~100KV  
 PT Secondary setting: 50.0~500.0V  
 Direct Input: Primary = Secondary < 500V  
**Current: 0 ~ 1/ ~ 5A (max.)**  
 CT Primary setting: 1~2999.9A  
 CT Secondary setting: 1.000~5.000A (Option)  
**Frequency: 50/60Hz ± 3Hz,**

### Max. input capability:

**Voltage:** 2 X rated voltage continuous  
 4 X rated voltage continuous 2 minutes  
**Current:** 3 X rated current continuous  
 10 X rated current continuous 10 seconds  
 50 X rated current 1 second (5A input type)

### Control function

**Setting point:** 3 sets (1 contact output for 3 set values)  
**Relay output:** 1set SPDT, 1A/230Vac, 3A/115V  
**Relay settings:** Up to 27 parameters relay setting  
**Relay mode:** Hi / Lo / Hi.HLd / Lo.HLd / do / oFF  
**Function:** Start delay/Start band/ Hysteresis /Relay hold

Start band: 0~9999 counts  
 Start delay: 0:00.0~9(Minutes):59.9(Second)  
 Run delay: 0:00.0~9(Minutes):59.9(Second)  
 Off delay: 0:00.0~9(Minutes):59.9(Second)  
 Hysteresis: 0~5000 counts

#### Analogue(Optional)

Accuracy:  $\leq \pm 0.1\%$  of F.S.; 16 bits DA converter  
 Ripples:  $\leq \pm 0.1\%$  of F.S.  
 Response time:  $\leq 100$  m-sec. (Input range 10~90%)  
 Isolation: 1500V between input and output  
 Output range: [Ra5L] **Voltage:** 0~5V / 0~10V(Default) / 1~5V / 0~2.5~5V / 1~3~5V / 0~5~10V / -5~+5V / -10~+10V  
**Current:** 0~10mA / 0~20mA / 4~20mA(Default)  
 4~12~20 mA / -10~10 mA / -20~+20 mA

#### Output load capability:

Function: **Voltage output:** 0~10V  $\geq 1000\Omega$   
**Current output:** (0)4~20mA  $\leq 530\Omega$   
 [RaH5] Maximum output value display setting  
 Setting range: -19999~29999  
 [RaL5] Minimum output value display setting  
 Setting range: -19999~29999  
 [RaL nL] (Output Hi): Output from 0.00~110.00%  
 [RaP r o] Setting range: -32768~+32767  
 [Ra5P n] Setting range: -32768~+32767

#### Digital adjustment:

#### RS 485 (Optional)

**Protocol:** Modbus RTU mode  
**Baud rate:** 1200/2400/4800/9600/19200/38400 bps selectable  
**Bits:** 8 bits  
**Parity check:** Odd \ even or none (with 1 or 2 stop bit) selectable  
**Address:** 1 ~ 255 selectable  
**Wire distance:** 1200M max  
**Terminal resistance:** 150 $\Omega$ .

#### Pulse output(Optional)

**Output mode:** 1 contacts open collector \ DC 30V, 100mA  
**Output parameters:** Effective energy : (AE.TL / -AE.TL)  
 Ineffective energy : ( RE.TL /-RE.TL)  
 Max frequency: 1000Hz ; duty cycle 50%  
 1 Pulse/1~9999 Count selectable.

#### Output range:

#### Pulse/Count:

#### Power supply

**Working voltage:** ADH:AC 85~264V \ DC 100~300V

ADL:AC/DC 20~56V

**Power consumption:** AC Power  $\leq 12$ VA , DC Power  $\leq 6$ W

#### Data storing:

By EEPROM

#### Safety

#### Insulation:

AC 2.0 KV for 1 min, Power/Input/Output/Casing

#### Isolation resistance:

$\geq 100$ M ohm at 500Vdc, Power/Input/Output/Casing

#### Signal isolation:

Power/Input/Relay/RS485/Analogue output/Pulse

#### EMC:

EN 55011:2002; EN 61326:2003

#### LVD:

EN 61010-1:2001

#### Working environment

#### Temperature.:

0~60 °C

#### Humidity(%RH):

20~95 %RH, Non condensing

#### Temp. coefficient:

$\leq 100$  PPM/°C

#### Storage:

-10~70 °C

#### Protection:

Front panel: IEC 529 (IP52); Case: IP30

#### Mechanical

#### Dimension:

96mm(W) x 48mm(H) x 120mm(D)

#### Mounting size:

92mm(W) x 44mm(H)

#### Case material:

ABS Non-flammable (UL 94V-0)

#### Installation:

Panel mounting

#### Terminal:

Plastic NYLON 66 (UL 94V-0)  
 10A 300Vac, M2.6, 16~22AWG

#### Weight:

350g(Aux. Power : ADH, ADL)

## ■ Front panel

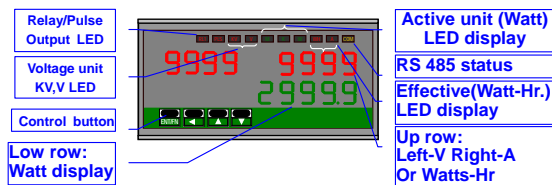





#### Display:

**Low row:** 5 Digits; 0.28"(0.71cm) Green LED (Watt)  
 10 Digits; 0.28"(0.71cm) Red LED  
**Up row:** 5 Digits; 0.28"(0.71cm) Red LED  
**Selection [d 5.5L]:** **When[μ-R]:** Left \ right each 4 Digits(V/A)  
**When[μ-H]:** 10 Digits totalizer (Watts-Hr)  
**Active power:** 3 green rectangular LED for W / KW  
 Effective : 3 rectangular red LED for Wh / KWh / MWh

#### I/O Status:

**PLS** **Pulse output display:** 1 rectangular red LED  
 During pulse transmission, LED will blink ; when  
 It blink faster mean Watt-Hr. accumulate more  
**COM** **RS 485 communication:** 1 rectangular orange LED  
 RS485 signal send/receive data \ LED will blink  
 When[COM]blink faster, data transfer speed is higher  
**RL1** **Relay output LED:** 1 rectangular red LED  
 LED on when relay output;;

#### Control button:

4 control buttons: Enter, function./ Shift / Up / Down  
 **Up key:** Value increase / return to previous level  
 **Down key:** Value decrease / enter next level  
 **Shift key:** Move decimal point / return to up level / escape setting  
 **Enter/Fun key:** Enter setting status / save and enter next function parameters

#### Password function:

4 digits password setting ; range 0000~9999  
 Password for parameters setting level needed.  
 Password can be change at parameters level  
 Please contact us if password lost.

#### Lock function:

4 lock modes, No lock/User level lock/Parameters  
 Setting lock/Lock all  
**None:** No lock \ all function and parameters selectable  
**User Level:** Open for viewing level, not able to change any setting if locked  
**Engineer Level:** Open for viewing level, not able to change any setting if locked  
**All:** Locked all level.

## ■ Casing dimension

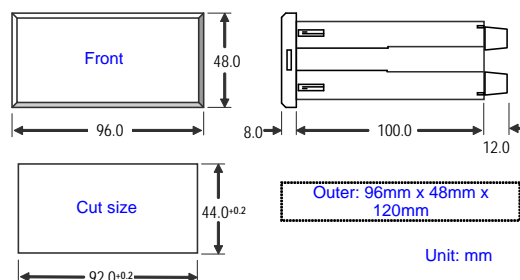

## ■ Installation

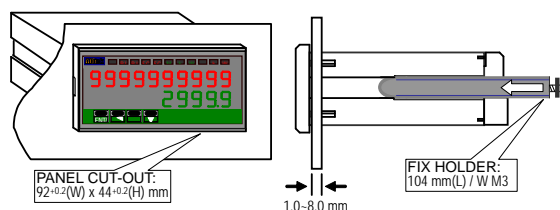

Please install meter within working temperature & humidity environment

## Wiring diagram

Please check input operating voltage before sending power, terminal connection to right number. Advise adding fuse/switch in front of power.

RS485 / Pulse / Relay wiring: AWG22~16(0.5~1.3mm<sup>2</sup>)  
Other: Wiring: AWG15~10(1.5~2.5mm<sup>2</sup>)

### Operating power connection

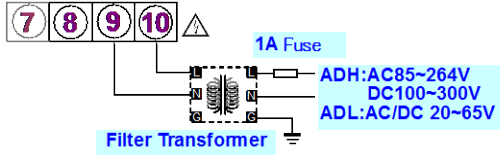

### Input connection

#### 1 Phase 2 wire (Unbalanced load)

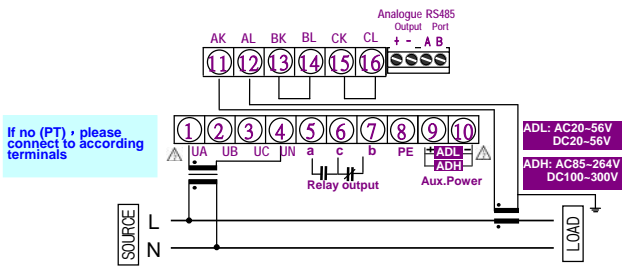

#### 1 Phase 3 wire (Unbalanced load)

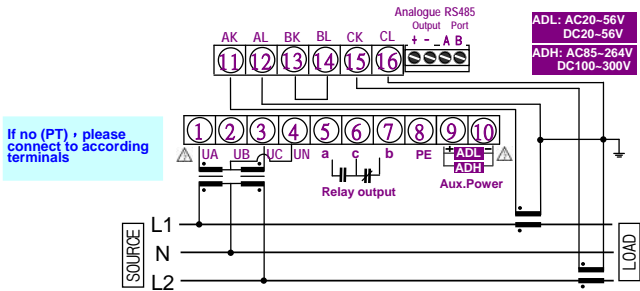

#### 3 Phase 3 wire (Unbalanced load 2CT)

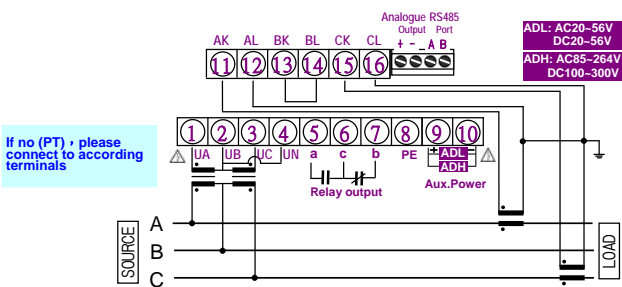

#### 3 Phase 3 wire (Unbalanced load 3CT)

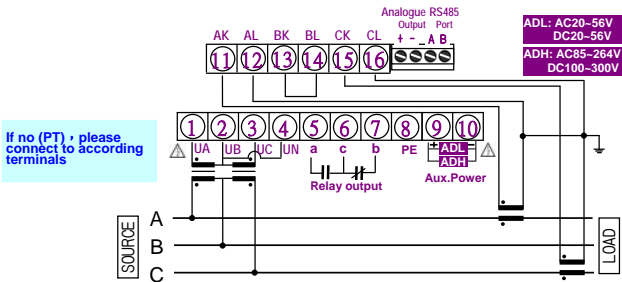

#### 3 Phase 3 wire (Balanced load 1CT)

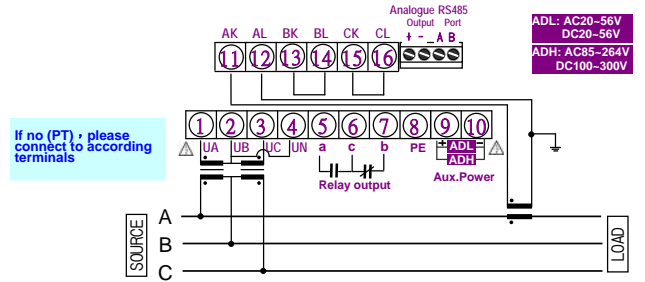

#### 3 Phase 4 wire (Unbalanced load 3CT)

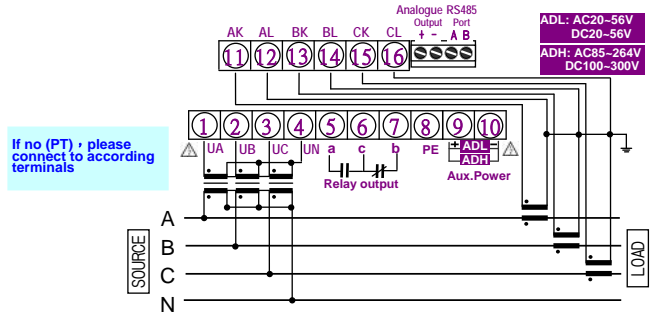

#### 3 Phase 4 wire (Balanced load 1CT)

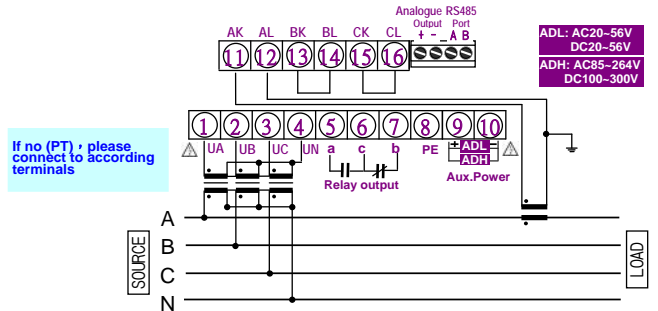

### Output signal connection

Due to limited terminals, pulse and relay output is using same terminal, only 1 output is available, will not have both. Please follow product code, specification on label and connection according to given on product

#### RS485 output

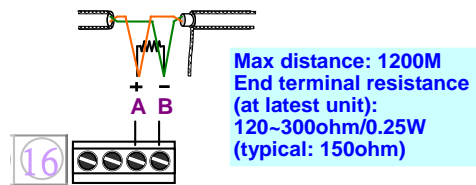

#### Pulse output

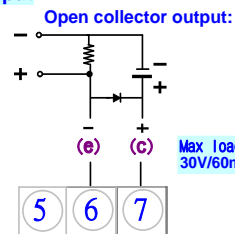

#### Relay output:



#### Analogue output

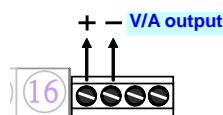

#### 1 Analogue + RS485 Output

