

# CS1-VA VOLT / CURRENT Meter

## DESCRIPTION

CS1-VA economic type Voltage/Current Indicator has been designed with high accuracy measurement, display and communication of 0~600V or 0~10A for DC/AC/TRMS.

They are also available 1 option of 1 Relay outputs, 1 Analogue output or 1 RS485 (Modbus RTU Mode) interface with versatile functions such as control, alarm, re-transmission or communication for a wide range of industrial and testing applications.



## FEATURE

- Measuring Voltage 0~600V or Current 0~10A for DC / AC / TRMS
- Option available 1 of 1 relay, 1 analogue output or RS485(Modbus RTU mode)
- 1 relay can be programmed individual to be a Hi / Lo / Hi Latch / Lo Latch energized with Start Delay / Hysteresis / Energized & De-energized Delay functions.
- Analogue output or RS 485 communication port in option
- CE Approved & RoHS

## APPLICATIONS

- Testing Equipments for Volt/Current Measuring, Alarm, Control and Communication with PC/PLC
- MCC panel, Machinery, Switch gear... for Voltage or Current Measuring, Alarm and Remote I/O with PC/PLC

## ORDERING INFORMATION

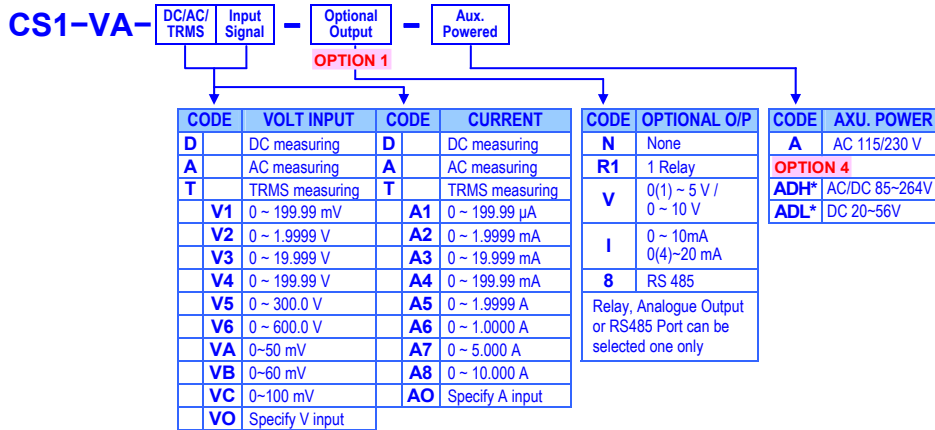

## TECHNICAL SPECIFICATION

Input		Input	
Measuring Range DC / AC / TRMS	Input Impedance	Measuring Range DC / AC / TRMS	Input Impedance
<b>Voltage</b>	0~50/~100 mV $\geq 5M$ ohm	<b>Current</b>	0~199.99 $\mu$ A 1K ohm
	0~199.99 mV $\geq 5M$ ohm		0~1.9999 mA 100 ohm
	0~1.9999 V $\geq 1M$ ohm		0~19.999 mA 10 ohm
	0~19.999 V $\geq 1M$ ohm		0~199.99 mA 1 ohm
	0~199.99 V $\geq 1M$ ohm		0~1.9999 A 0.05 ohm
	0~300.0 V $\geq 2M$ ohm		0~5.000 A 0.02 ohm
	0~600.0 V $\geq 2M$ ohm		0~10.000 A 0.01 ohm

- Calibration:** Digital calibration by front key
- A/D converter:** 16 bits resolution
- Accuracy:** DC:  $\leq \pm 0.04\%$  of FS  $\pm 1C$   
AC:  $\leq \pm 0.1\%$  of FS  $\pm 1C$
- Sampling rate:** 15 cycles/sec
- Response time:**  $\leq 100$  m-sec.(when the  $R_{UL} = "1"$ ) in standard

### Display & Functions

- LED:** Numeric: 5 digits, 0.8"(20.0mm)H red high-brightness LED  
Relay output indication: 1 square red LED  
RS 485 communication: 1 square orange LED  
E.C.I. function indication: 1 square green LED  
Max/Mini Hold indication: 2 square orange LED  
Down key function indication (Reset for Max. (Mini.) Hold / PV Hold / Relative. PV): 1 square green LED
- Display range:** -19999~29999;

- Scaling function:** L<sub>5C</sub>: Low Scale; Settable range: -19999~+29999  
H<sub>5C</sub>: High Scale; Settable range: -19999~+29999  
Programmable from 0 / 0.0 / 0.00 / 0.000 / 0.0000
- Decimal point:** 0.0FL, when input is over 20% of input range Hi  
-0.0FL, when input is under -20% of input range Lo
- Over range indication:** Maximum and Minimum value storage during power on.
- Under range indication:** PV / Max(Mini) Hold / RS 485 Programmable
- Max / Mini recording:** Relative PV / PV Hold / Reset for maxi(mini) hold /
- Display functions:** Reset for relay energized latch programmable
- Front key functions:** Settable range: -19999~29999 counts
- Low cut:** P<sub>uP</sub>ro: Settable range: -19999~+29999
- Digital fine adjust:** P<sub>uSP</sub>n: Settable range: -19999~+29999

### Reading Stable Function

- Average:** Settable range: 1~99 times
- Moving average:** Settable range: 1(None)~10 times
- Digital filter:** Settable range: 0(None)/1~99 times

### Control Functions(option)

- Set-points:** One set-point
- Control relay:** 1 Relay, FORM-C, 5A/230Vac, 10A/115V
- Relay energized mode:** Energized levels compare with set-points: Hi / Lo / Hi.HLd / Lo.HLd programmable
- Energizing functions:** Start delay / Energized & De-energized delay / Hysteresis Energized Latch
- Start band**(Minimum level for Energizing): 0~9999counts
- Start delay time:** 0:00.0~9(Minutes):59.9(Second)
- Energized delay time:** 0:00.0~9(Minutes):59.9(Second)
- De-energized delay time:** 0:00.0~9(Minutes):59.9(Second)
- Hysteresis:** 0~5000 counts

### Analogue output(option)

<b>Accuracy:</b>	≤± 0.1% of F.S.
<b>Ripple:</b>	≤± 0.1% of F.S.
<b>Response time:</b>	≤100 m-sec. (10~90% of input)
<b>Isolation:</b>	AC 2.0 KV between input and output
<b>Output range:</b>	Specify either Voltage or Current output in ordering <b>Voltage:</b> 0~5V / 0~10V / 1~5V programmable <b>Current:</b> 0~10mA / 0~20mA / 4~20mA programmable
<b>Output capability:</b>	<b>Voltage: 0~10V: ≥ 1000Ω;</b> <b>Current: 4(0)~20mA: ≤ 600Ω max</b>
<b>Functions:</b>	<b>RaHS</b> (output range high): Settable range: -19999~29999 <b>RaLS</b> (output range Low): Settable range: -19999~29999
<b>Digital fine adjust:</b>	<b>RaPno</b> : Settable range: -38011~+27524 <b>RaSPno</b> : Settable range: -38011~+27524

### RS 485 Communication(option)

<b>Protocol:</b>	Modbus RTU mode
<b>Baud rate:</b>	1200/2400/4800/9600/19200/38400 programmable
<b>Data bits:</b>	8 bits
<b>Parity:</b>	Even, odd or none (with 1 or 2 stop bit) programmable
<b>Address:</b>	1 ~ 255 programmable
<b>Remote display:</b>	to show the value from RS485 command of master
<b>Distance:</b>	1200M
<b>Terminate resistor:</b>	150Ω at last unit.

### Electrical Safety

<b>Dielectric strength:</b>	AC 2.0 KV for 1 min, Between Power / Input / Output / Case
<b>Insulation resistance:</b>	≥100M ohm at 500Vdc, Between Power / Input / Output
<b>Isolation:</b>	Between Power / Input / Relay, Analogue, RS485
<b>EMC:</b>	EN 55011:2002; EN 61326:2003
<b>Safety(LVD):</b>	EN 61010-1:2001

### Environmental

<b>Operating temp.:</b>	0~60 °C
<b>Operating humidity:</b>	20~95 %RH, Non-condensing
<b>Temp. coefficient:</b>	≤100 PPM/°C
<b>Storage temp.:</b>	-10~70 °C
<b>Enclosure:</b>	Front panel: IEC 529 (IP52); Housing: IP20

### Mechanical

<b>Dimensions:</b>	96mm(W) x 48mm(H) x 72mm(D)
<b>Panel cutout:</b>	92mm(W) x 44mm(H)
<b>Case material:</b>	ABS fire-resistance (UL 94V-0)
<b>Mounting:</b>	Panel flush mounting
<b>Terminal block:</b>	Plastic NYLON 66 (UL 94V-0) #A1~A3(current input): 20A/300Vac, M3.5, 12~22AWG Others: 10A 300Vac, M2.6, 16~22AWG
<b>Weight:</b>	350g

### Power

<b>Power supply:</b>	AC115/230V,50/60Hz; Optional: AC 85~264V, DC 100~300V or DC 20~56V
----------------------	--

**Power consumption:** 3.0VA maximum

**Back up memory:** By EEPROM

## FRONT PANEL

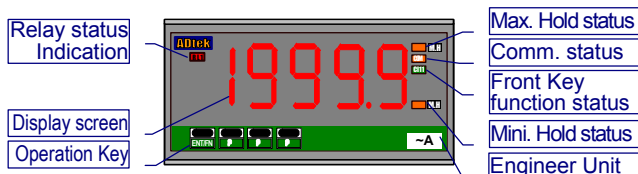

## DIMENSIONS

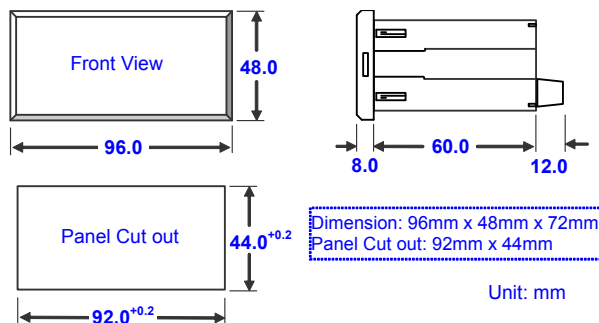

## INSTALLATION

The meter should be installed in a location that does not exceed the maximum operating temperature and provides good air circulation.

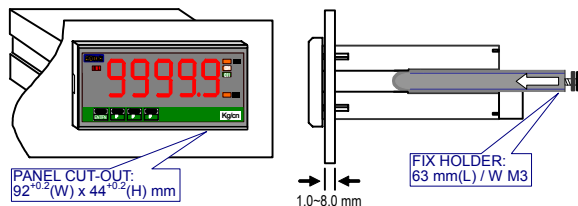

## CONNECTION DIAGRAM

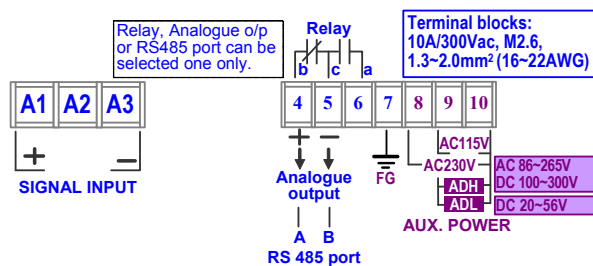

Please check the voltage of power supplied first, and then connect to the specified terminals. It is recommended that power supplied to the meter be protected by a fuse or circuit breaker.

### Power Supply

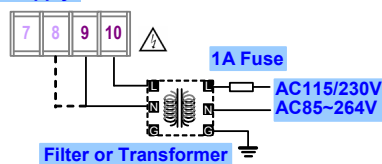

### Input connection

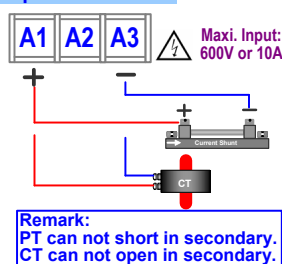

### RS485 Communication Port

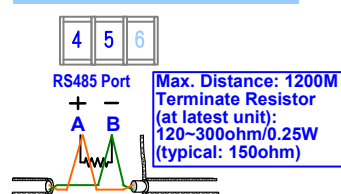

Amend: 2010/4/26: Modify the terminals and range for DC power supply from AC/DC 20~56V to DC 20~56V.

# FUNCTION DESCRIPTION

## Scaling function:

Setting the [LαSC] (Low scale) and [HαSC] (High scale) in [INPUt GRoUP] to relative input signal. **Reverse scaling will be done too.** Please refer to the figure as below,

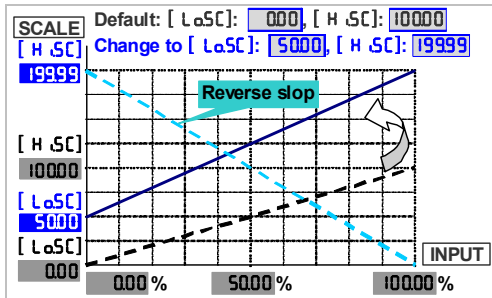

\*Too narrow scale may course display lower resolution.

Reset for Max(Mini) Hold: when the [dSPLY] in [INPUt GRoUP] set to be [HrHd] or [MinHd], [dRPEY] function can be set to be [rSt] to reset the display when it is holding in maxi or mini value.  
 Reset for relay energized latch: when the [rY Ld] in [RELAY GRoUP] set to be [HrLd] or [LrLd], [dRPEY] function can be set to be [YrSt] to reset the relay when it is energizing and latching.

## Display & Functions

### Max / Mini recording:

The meter will storage the maximum and minimum value in [user level] during power on in order to review drifting of PV.

### Display functions:

(Please refer to step A-07)

PV / Max(Mini) Hold / RS 485 programmable in [dSPLY] function of [INPUt GRoUP]

Present Value [Pu]: The display will show the value that Relative to Input signal.

Maximum Hold [HrHd] / Minimum Hold [MinHd]:

The meter will keep display in maximum (minimum) value during power on, until press front key to reset (If the down key function in [INPUt GRoUP] has been set to [rSt].)

- ▶ Please find the [RPH] sticker that enclosure the package of the meter to stick on the right side of square orange LED

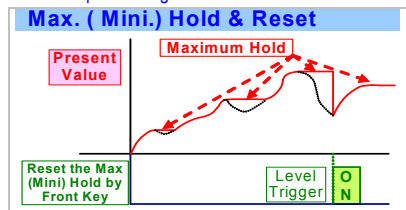

Remote Display by RS485 command [F5485]:

The meter will show the value that received from RS485 sending. In past, The meter normally receive 4~20mA or 0~10V from AO or digital output from BCD module of PLC. We support a new solution that PV shows the value from RS485 command of master can so that can be **save cost and wiring** from PLC.

### Front key functions:

Relative PV / PV Hold / Reset for maxi(mini) hold / Reset for relay energized latch programmable in [dRPEY] function of [INPUt GRoUP]

Relative PV [ELPu]: [dRPEY] function can be set to be [ELPu] function. When user press the [key], the display will show the differential value(ΔPV), until press [key] again.

- ▶ Please find the [RPL] sticker to stick on the right side of square green LED.

PV Hold [PvHd]: [dRPEY] function can be set to be [PvHd] function. When user press the [key], the display will be hold until press the [key] again.

- ▶ Please find the [PvH] sticker to stick on the right side of square green LED.

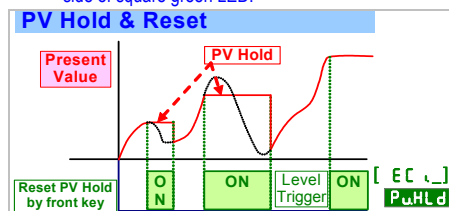

### Low cut:

If the setting value is positive, it means when the absolutely value of PV ≤ Setting value, the display will be 0. If the setting value is negative, it means when the PV under setting value (PV ≤ -Setting value), the display will be setting value.

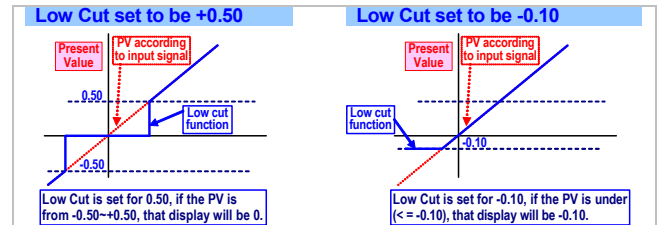

### Digital fine adjustment:

Users can get Fine Adjustment for Zero & Span of PV by front key of the meter, and "Just Key In" the value which user want to show in the current input signals.

Especially, the [Pwr0] & [PvSpn] are not only in zero & span of PV, but also any lower point for [Pwr0] & higher point for [PvSpn]. The meter will be linearization for full scale.

The adjustment can be clear in function [P5CLR]

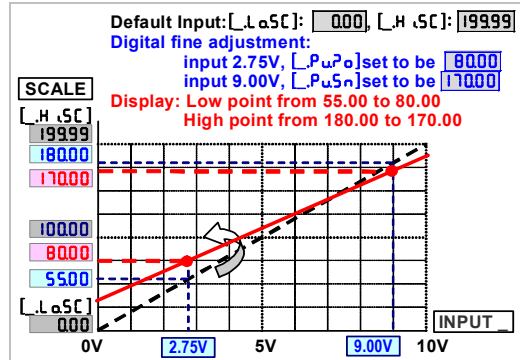

### Reading Stable Function

#### Average:

Basically, the sampling rate of meter is 15cycles/sec. If the function set to be 3 times, It means the meter will update of display will be 5 times/sec.

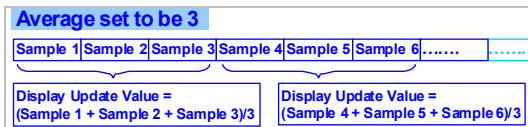

Remark: The higher average setting will cause the response time of Relay and Analogue output slower.

#### Moving average:

If the function to be set 3 times, the meter will update delay in first 3 samples, then it will update 15 times/sec continuously.

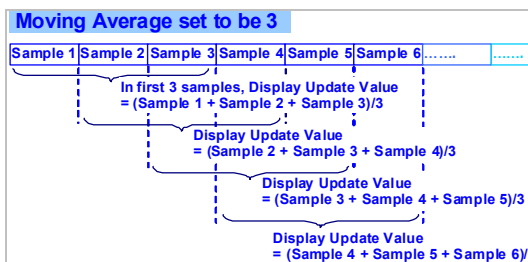

Remark: The higher moving average setting wouldn't cause the response time of Relay and Analogue output slower after first 3 samples.

#### Digital filter:

The digital filter can reduce the magnetic noise in field.

**Control functions(option)**

**Relay energized mode:**

Hi / Lo / Hi.HLd / Lo.HLd programmable  
**H** : Relay will energize when PV > Set-Point  
**L** : Relay will energize when PV < Set-Point

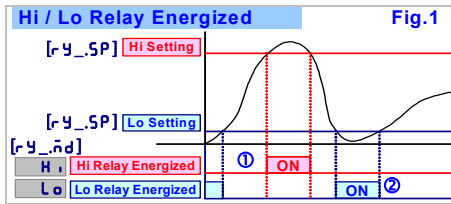

**Hi.HLd (Lo.HLd):** When the PV is Higher (or lower) than set-point, the relay will be energized and latch until manual reset by from key in [ user level] or press down key to reset (If the [dLSEY] function set to be [YrSt])

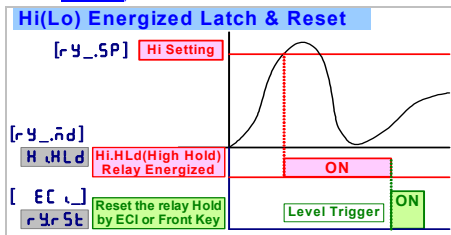

**Energized functions:**

Start delay / Energized & De-energized delay / Hysteresis

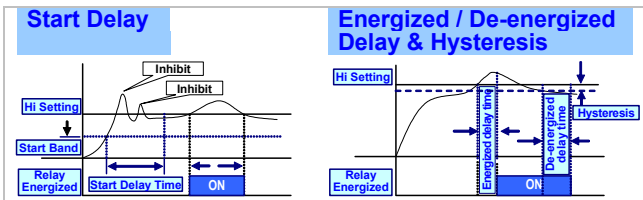

**Analogue output(option)**

Please specify the output type either an 0~10V or 4(0)~20mA in ordering. The programmable output low and high scaling can be based on various display values. Reverse slope output is possible by reversing point positions.

**Output range:**

Voltage: 0~5V / 0~10V / 1~5V programmable  
 Current: 0~10mA / 0~20mA / 4~20mA programmable

**Functions:**

**RoHS** (output range high): setting the Display value High to versus output range High(as like as 20mA in 4~20)  
**RoLS** (output range Low): setting the Display value Low to versus output range Low(as like as 4mA in 4~20)

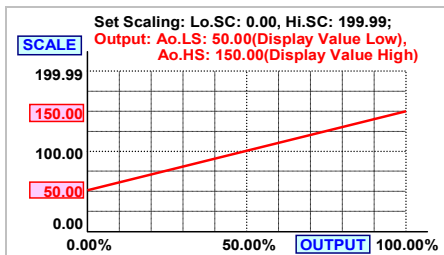

The range between **RoHS** and **RoLS** should be over 20% of span at least; otherwise, it will be got less resolution of analogue output.

**Fine zero & span adjustment:**

Users can get Fine Adjustment of analogue output by front key of the meter. Please connect standard meter to the terminal of analogue output. To press the front key (up or down key) of meter to adjust and check the output.

**[RoZro]**: Fine Zero Adjustment for Analog Output;  
 Settable range: -38011~27524;

**[RoSPn]**: Fine Span Adjustment for Analog Output;  
 Settable range: -38011~27524;

**RS 485 Communication(option)**

The RS485's protocol is Modbus RTU mode, and baud rate up to 38400 bps. It's convenience to remote monitoring, display for reading.

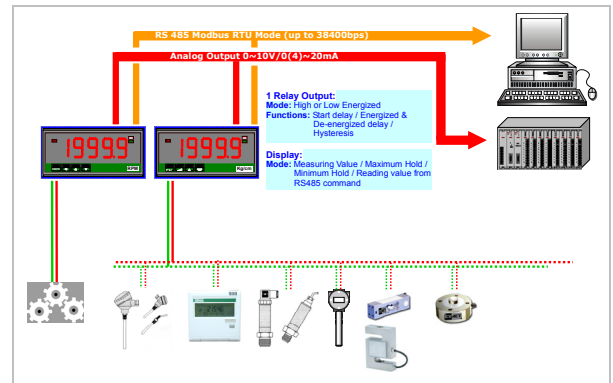

**Remote display:**

The meter will show the value that received from RS485 command. In past, The meter normally receive 4~20mA or 0~10V from AO or digital output from BCD module of PLC. We support a new solution that PV shows the value from RS485 command of master so that can be **save cost and wiring** from PLC. When the [d5PL9] set to be RS485, it means, the PV screen will show the number from RS485 command & data. The data (number) will be same as PV that will compare with set-point, analogue output and ECI functions so that is to control analogue output, relay energized and so on.

**CS1 APPLICATION FOR REMOTE DISPLAY FROM RS485 COMMAND**

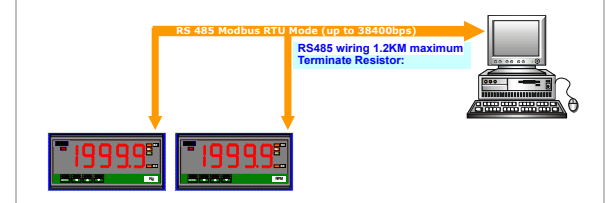

## ■ ERROR MESSAGE

BEFORE POWER ON, PLEASE CHECK THE SPECIFICATION AND CONNECTION AGAIN.

SELF-DIAGNOSIS AND ERROR CODE:

DISPLAY	DESCRIPTION	REMARK
ouFL	Display is positive-overflow (Signal is over display range)	(Please check the input signal)
-ouFL	Display is negative-overflow (Signal is under display range)	(Please check the input signal)
ouFL	ADC is positive-overflow (Signal is higher than input 120%)	(Please check the input signal)
-ouFL	ADC is negative-overflow (Signal is lower than input -120%)	(Please check the input signal)
EEP → FAiL	EEPROM occurs error	(Please send back to manufactory for repaired)
AiCnG → Pu	Calibrating Input Signal do not process	(Please process Calibrating Input Signal)
AiC → FAiL	Calibrating Input Signal error	(Please check Calibrating Input Signal)
RoCnG → Pu	Calibrating Output Signal do not process	(Please process Calibrating Output Signal)
RoC → FAiL	Calibrating Output Signal error	(Please check Calibrating Output Signal)

## ■ OPERATING KEY

\*Please access to the Programming Level to check and set the parameters when users start to run the meter

■ **Operating Key:** 4 keys for Enter(Function) / Shift(Escape) / Up key / Down key

■ The meter has designed operation similar as PC's and . In any page, press key means "enter" or "confirm setting", and press key means "escape()" or "shift".

■ In Programming Level, the screen will return to Measuring Page after do not press any key over 2 minutes, or press for 1 second.

	Function Index	Setting Status
(= ) Enter/Fun key	(1) In any page, press  to access the level or function index (2) From the function index to access setting status	(3) Setting Confirmed, save to EEPROM and go to next function index
(= ) Shift key	(1) In measuring page, press  for 1 second to access user level. (2) In function index, press  for 1 second to go back upper level. (3) In function group index, press  for 1 second to go back measuring page	(4) In setting status, press  to Shift the setting position. (5) In setting status, press  for 1 second to abort setting and go back this function index.
(= ) Up key	(1) In function index, press  to go back to previous function index	(2) In setting status for function, press  to select function (3) During number Setting, press  can roll the digit up
(= ) Down key	(1) In Function Index Page, press  will go to the next Function Index Page.	(2) In setting status for function, press  to select function (3) During number Setting, press  can roll the digit down.

## ■ FRONT PANEL

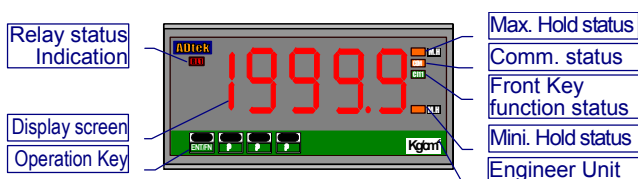

### ■ Numeric Screens

0.8" (20.0mm) red high-brightness LED for 4 2/3 digital present values.

### ■ I/O Status Indication

● **Relay Energized:** 1 square red LED

display when Relay 1 energized;

● **RS485 Communication:** 1 square orange LED

will flash when the meter is receive or send data, and flash quickly means the data transient quicker.

● **Max/Mini Hold indication:** 2 square orange LEDs

displayed: When the display function has been selected in Maximum or Minimum Hold function.

### ■ Stickers:

Each meter has a sticker what are functions and engineer label enclosure.

● **Relay energized mode:**

### ● Down key functions mode:

PV.H(PV Hold) / Tare / DI(Digital Input)

M.RS(Maximum or Minimum Reset) /

R.RS(Reset for Relay Latch)

### ● Engineer Label: over 80 types.

■ **Operating Key:** 4 keys for Enter(Function) / Shift(Escape) / Up key / Down key

■ **Pass Word:** Settable range:0000~9999;

User has to key in the right pass word so that get into **[Programming level]**. Otherwise, the meter will go back to measuring page. If user forgets the password, please contact with the service window.

■ **Function Lock:** There are 4 levels programmable.

● **None** : no lock all.

● **User Level** : User Level lock. User can get into User Level for checking but setting.

● **Programming Level** : Programming level lock.

User can get into programming level for checking but setting.

● **ALL** : All lock. User can get into all level for checking but setting.

■ **Front Key Function:**

● The Key can be set to be / / programmable.



